

USN-HE06PA-4 Technical Data

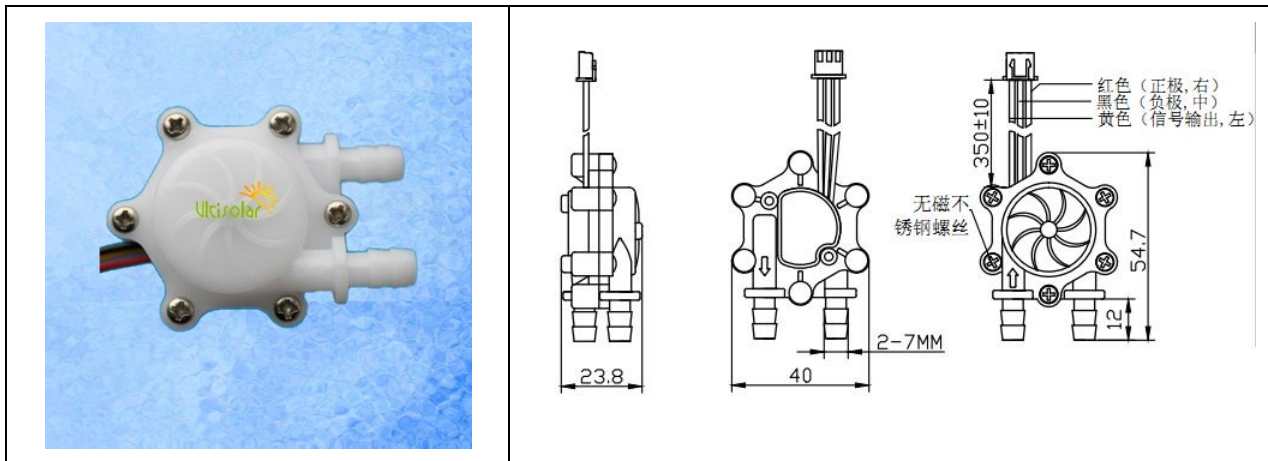

外观 Appearance		图纸 Diagram	
进水口 Inlet	6mm 外径插管 For 6mm ID pipe	出水口 Outlet	6mm 外径插管 For 6mm ID pipe
测量范围 Measuring Range	0.3-4.5L/min	使用介质 Liquid	Water under 60°C (Tap Water Standard)
工作电压范围 Working Voltage range	DC4.5-18V	额定工作电压 Rated working voltage	DC 5V
输出电压 Output voltage	高电平 4.5V 以上, 低电平 0.5V 以下。 High level 4.5V and above; low level 0.5V and below		
最大工作电流 Max. Working Current	10mA	脉冲输出占空比 Pulse output duty cycle	50+ -10%
密封性 Tightness	封闭各孔, 加 0.8MPa 水压试验 1 分钟无渗漏和变形 Seal up all the holes, and inflate with 0.8MPa water, after 1 minute, no leakage and deformation.		
绝缘电阻 insulation resistance	100M 以上 100M and above	累计流量特性 Accumulated flow	1L=820Hz ±8%
流量 脉冲 特性 Flow Pulse Features	脉冲 (f) = 14 * 流量 (Q) (l/min) 误差: ±8% Pulse(f) = 14 * flow rate(Q)(l/min) error: ±8%		
流量计接线图 Wire diagram			

- 1、当磁性材料或对传感器产生磁力的材料靠近传感器时, 其特征可能有所变化。
 - 2、为了避免颗粒、杂物进入传感器, 在进水口必须安装过滤网。
 - 3、水流传感器可任意方向安装, 但要避开有较强震动和摇晃的环境, 以免影响传感器的测量精度。
1. When magnetic material is close with the sensor, its characteristics may vary.
 2. In order to avoid particle debris, the sensor must be installed after a filter.
 3. The flow sensor can be installed in any direction, but should be avoided from strong vibrating and shaking environment, so as not to affect the accuracy.